

## Standard installation method

1	Purposes of standard installation method
2	Wind load resistance of Nichiha panels
3	Main prohibited matters on installation
4	Standard installation procedure
5	Layout design of Nichiha panels
6	Rainscreen system
7	Accuracy of wall stud (steel frame)
8	Panel notching
9	Repair coating
10	Storage/handling/transportation
11	Procedure and point of sealing work
12	Precaution for sealing work
13	Sealant
14	Prevention of three-sided adhesion of sealant

# Standard installation method

## 1 Purposes of standard installation method

Standard installation method, directed in these documents, have next following purposes.

- (1) To maintain siding performance for long periods.
- (2) To exert the expected exterior wall function.
- (3) Required conditions of quality assurance.
- (4) To inform cautions and prohibited matters.



## 2 Wind load resistance of Nichiha panels

The table below shows the permissible wind pressure performance of Nichiha Panel.

Installation with clips is only applicable for panels which thickness is more than 16mm.

Vertical installation with 15mm clip (JE715) is less than 13m, and Nichiha S Series is 16m or less in height.

### ■ Wind load resistance (Nichiha internal testing)

#### (1) Wooden frame

(negative-pressure, unit: Pa)

Fixing means Fixing interval (mm)	Nails	5mm clips (JE555)	15mm clips (JE825)	5mm long clips (JEL560)	15mm long clips (JEL860)
@500	1725	1300	1155	1700	2545
@455	1905	1600	1200	2050	2800

● Fix clips with Nichiha screws (JK1150).

#### (2) Steel frame

(negative-pressure, unit: Pa)

Fixing means Fixing interval (mm)	5mm clips (JE555)	15mm clips (JE825)	5mm long clips (JEL560)	15mm long clips (JEL860)	5mm Clips + Additional screw (JE555 + screw)	15mm Clips + Additional screw (JE825 + screw)
@606	1125	1125	1350	2065	3150	3250
@500(※1)	1175	1280	1735	2550	3320	3700
@455	1200	1350	1900	2750	3400	3900
@303	1900	1850	2750	4130	-	-

\*1: Calculated values from the test results of @606mm and @455mm.

# Standard installation method

## 3 Main prohibited matters on installation

Do not install Nichiha panel on following parts and by installation way. It may cause failure.



### 1 Use on sloping parapet

Because of severe environmental condition compared to vertical wall, it may cause deterioration of coating, frost damage, or water leaking.  
 ➔ Use roofing materials.

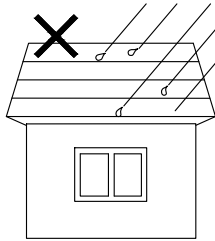

### 6 Installation on wall where window sash recessed

Water can enter easily inside of external wall, and it may cause rain leak or frost damage.  
 ➔ Window sash must be projected out from the wall. In case of recessed, install effective frame for waterproof together.

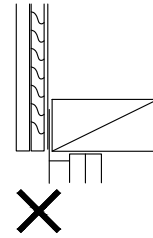

### 2 Walls which are constantly exposed to water such as bathroom walls

Temperature and humidity are high and panels get water directly, so warp of the panels, frost damage, decrease in strength, or cracking may happen.

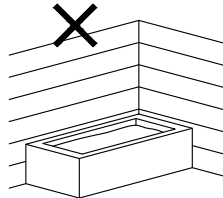

### 7 Coping without air vent on parapet

Because it does not meet ventilating construction method, condensation or frost damage may happen.  
 ➔ Install air vent which can be waterproof

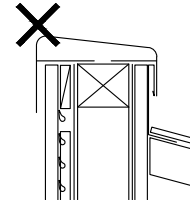

### 3 Installation on chimneys

The panels deteriorate due to heat. In addition, as water is generated in chimney and exudes out, the panels absorb water from the back side, then it may cause warp or frost damage.

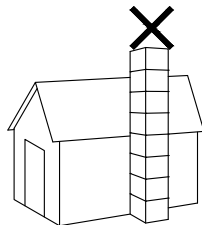

### 8 Installation of copings by sloping outward

If copings are installed by sloping outward, a large amount of rainwater flows on the panel surface, and it may cause dirt or frost damage.

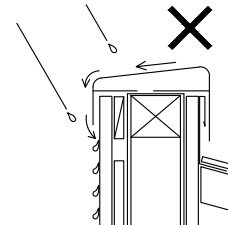

### 4 Installation on high temperature parts such as fireplace

In high temperature parts, the panels may warp or crack because moisture in the panels is dried up.

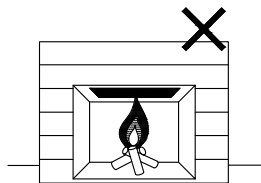

### 9 Painting cement stucco thickly on the panels (Including mortar painting)

Thick paint lacks adhesion, so it may cause peeling or breakage.

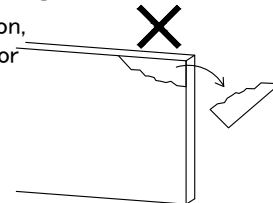

### 5 Single-sided fence which back side is exposed

Finishing of the back side of the panels is only sealer. Repetition of wet and drying in the back side may causes the panel warp.  
 ➔ Finish fence to be double-sided, and install copings to the top part.

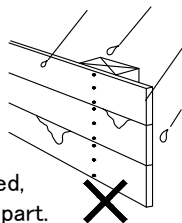

### 10 Putting tiles on the panels directly

It may cause cracking or peeling of the tiles.

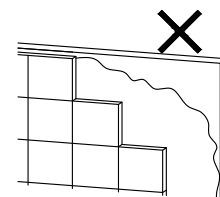

# Standard installation method

## 3 Main prohibited matters on installation

Do not install Nichiha panel on following parts and by installation way. It may cause failure.



### 11 Embedding in foundation mortar

Due to water absorption from the panel edge or back surface, it may cause frost damage, paint peeling, or getting moldy.

➔ Install base flashing and leave 10–15 mm space between the flashing and the bottom edge of the panel.

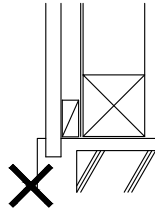

### 16 Horizontal installation of panels

for only vertical (Excluding vertical-cum-hrizontal type)

The panels for only vertical use have 2 mm gap on shiplap joint part. If this type of panels is installed horizontally, water is collected there, and it may cause dirt or frost damage due to water absorption.

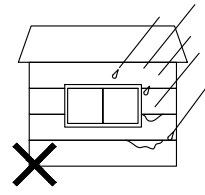

### 12 Panels touch the flashing

Due to water absorption from the panel edge, it may cause frost damage, paint peeling, or getting moldy.

➔ Leave 10–15 mm space between the flashing and the bottom edge of the panel.

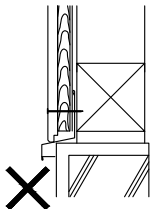

### 17 Random installation of panels

It may cause poor application of sealant in joint part that is between backing rod or joint backer strip and panels, and cause water leaking.

Also, water can infiltrate from shiplap joint part. (Excluding some installation methods)

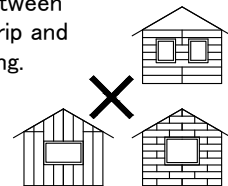

### 13 Using clips instead of starter strip

If used clips instead of starter strip, it can be difficult to ensure horizontal level on lowest panels, and gap at the joint can appear easily.

➔ Be sure to install starter strip on bottom horizontally, and begin to install panels.

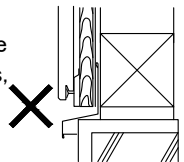

### 18 Diagonal installation of panels

It may cause poor application of sealant in joint part that is between backing rod or joint backer strip and panels, and cause water leaking.

Also, water can infiltrate from shiplap joint part.

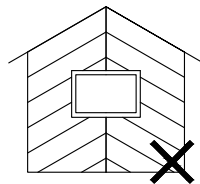

### 14 Butt joint of panels

If applying sealant on butt joint of panels, sealant can not follow with the movement of joint and gap at the joint can appear, so it may cause rain leak or frost damage.

Also, if panels touch the middle flashing, it may cause frost damage due to water absorption from the panel edge.

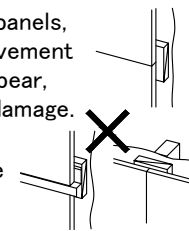

### 19 Horizontal install of pre-formed corner trim

(In case of not using specified accessories)

It obstructs to discharge rainwater or condensed water, and may cause rain leak or frost damage.

➔ Be sure to use specified member for overhang part.

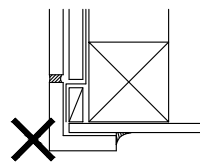

### 15 Installation under the sash without flashing

Rain water which drops from sash frame flows on the panel surface, and it may cause dirt or function degradation.

➔ Use sash which projected out from the wall by over 30 mm, or flashing whose ends are finished with backboards.

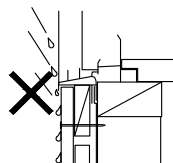

### 20 Installing air vent after siding work

If air vent is installed after siding work, it can get humid easily inside of external wall, so it may cause condensation, rain leaking, or frost damage.

➔ Install ventilation hood or duct before siding work.

The outlet must be projected out by over 30 mm from the wall.

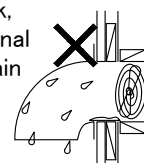

# Standard installation method

## 3 Main prohibited matters on installation

Do not install Nichiha panel in following parts and by installation way. It may cause failure.



### 21 Inappropriate overhang when installed vertically with clip

The panels may drop unless starter strips are fixed with Nichiha screw, and clips are firmly fixed on right above the starter strip.

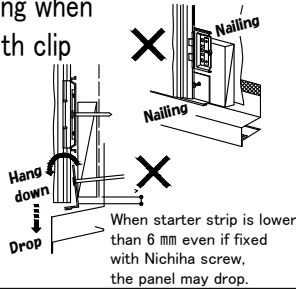

### 26 Inappropriate repair of nail heads

Spreading out touch-up paint wider than the nail head, applying thickly, insufficient stirring of touch-up paint, or applying sealant may cause the repair part to be noticeable by aging.

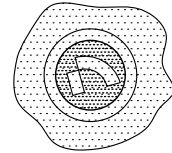

➔ Repair only conspicuous part and apply to minimally area not to spread out.

### 22 Too long cut, or installation without cutting below the minimum processing width

It may cause the panels break.

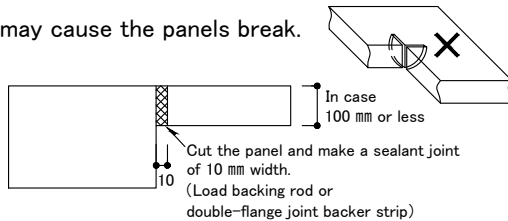

### 27 Direct installation to substrate

Ventilation in external wall will be prevented if the panels are installed directly to the substrate. Also, vibration of the substrate is transmitted to the panels, leading its chipping or cracking.

➔ Install furring strips or use 15 mm Clips, and ensure ventilation in external wall.

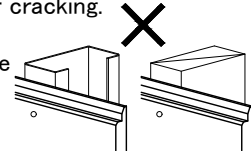

### 23 Shortage of distance to edge

If the distance from fixing position to edge is less than 20 mm when nailing or less than 30 mm when fixing with screws, the panels can be cracked.

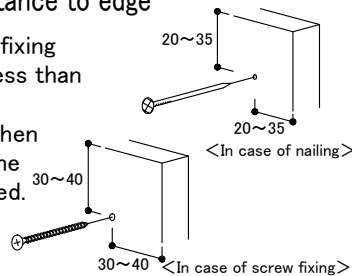

### 24 Installation without fixing single/double-flange joint backer strip

It may cause lateral slip of the panels and peeling or bulge of sealant in vertical joint when installing without fixing single/double-flange backer strip.

Fix it with nails @1m or less.

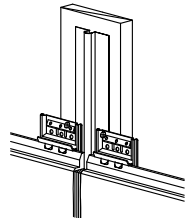

### 25 Not using of single-flange joint backer strip in internal corners or openings

It may cause lateral slip of the panels and peeling or bulge of sealant in vertical joint in internal corners or openings without single-flange joint backer strip.

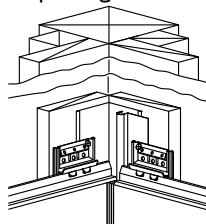

# Standard Installation method

## 4 Standard installation procedure

Check and collation of the drawings and the pane layout (horizontal/vertical, and joint positions)



Check of the substrate and sash



Position marking and installation of flushing



Application of building wrap



Installation of furring strips



Position marking of accessories



Installation of accessories



Installation of the panels and corner members



Sealing work



Panel painting (in case of unpainted products)



Repair, inspection and cleanup



# Standard installation method

## 5 Layout design of Nichiha panels

### (1) Points of layout work

- The purposes of layout work are these: making the exterior wall up beautiful, preventing rainwater from entering, and reducing cut loss. It is important to keep balance of the three.
- In principle, design the panel layout that positions of vertical joints are symmetric with respect to the center line of the wall.
- If it is difficult to set both vertical joints and pillars/studs the same position because of beauty reasons or owner's request, add studs in advance to avoid installation troubles.

### (2) Layout in horizontal installation

- There are two ways in horizontal installation layout; (A) is to align the centers of the panels and the wall, and/or (B) is to align vertical joints of the panels and the center of the wall. Consider the positions of the openings and appearance of the wall, and decide which (A) or (B) way to select.
- It is possible to reduce cut loss of the 6-foot panels and vertical joints of the 10-foot panels when you design the panel layout that following below calculation formula.

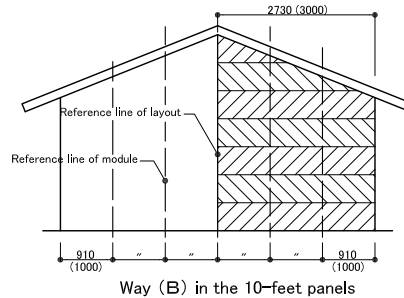
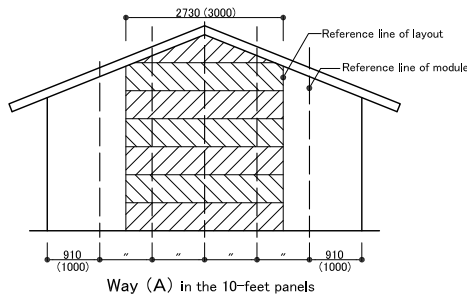

Put total width of panel installation area, which is from external/internal corner to ones in the other side, as "X", and put the panel length as "Y", 6-foot panels are 1,820 mm and 10-foot panels are 2,730 or 3,000 mm. Then substitute the former numeric values into following formula and calculate "N".

$$X \div Y = N \text{ (Round up to decimal place.)}$$

If N is an odd number, adopt (A). If N is even number, adopt (B).

### (3) Layout in vertical installation

- For vertical installation, make the panels the same size on the left and right of the wall and symmetric. Be cautious not to make too narrow panel in corner parts.
- To prevent from using too narrow panel, select an installation way which makes symmetric with respect to "the vertical joint" or "the center line of the panel".

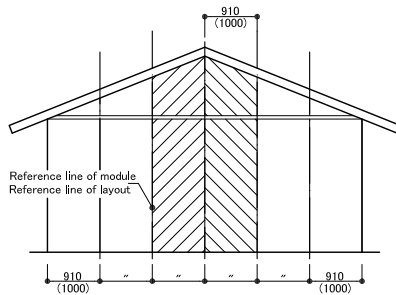

<When the ship-lap joint is at the center of the wall>  
Divide the wall outer width by 2  
and decimal place is over 0.5

Symmetric with respect to "the vertical joint"

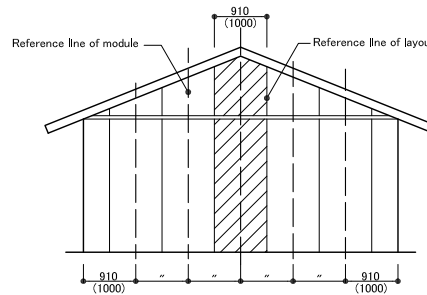

<When the panel center is at the center of the wall>  
Divide the wall outer width by 2  
and decimal place is over 0.5

Symmetric with respect to "the center line of the panel"

# Standard installation method

## 5 Layout design of Nichiha panels

### (4) Pattern matching (grooves/joint pattern)

- For patterns which have straight grooves or straight pattern joints, cut the panels accurately so that the groove lines can connect straightly.

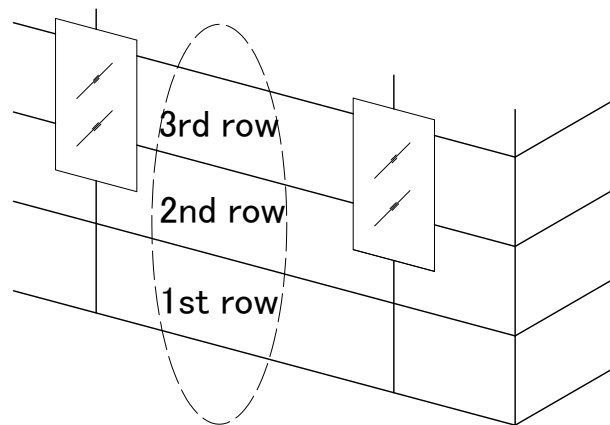
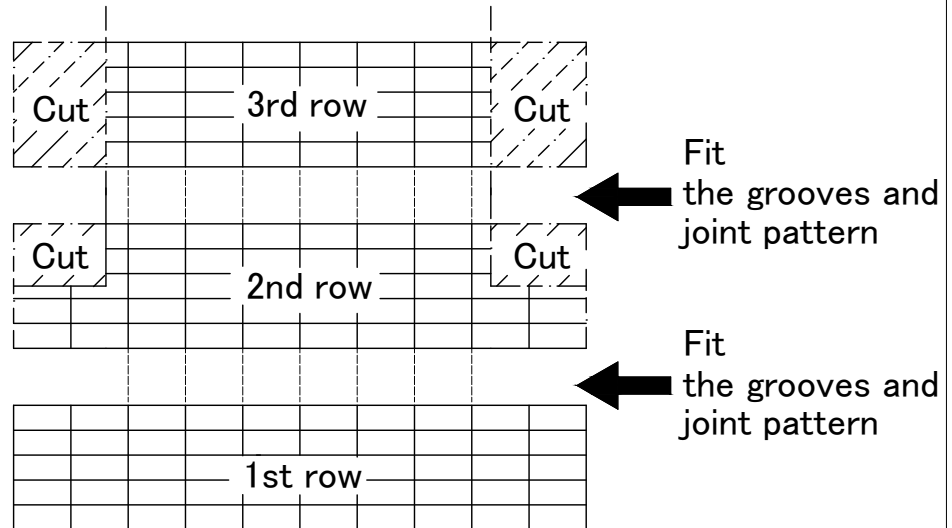

### Note:

There are some panels which require pattern matching, and check the patterns by the brochure or samples in advance. Please contact us if you are unsure.



# Standard installation method

## 6 Rainscreen system

Structure where air in the wall flows effectively

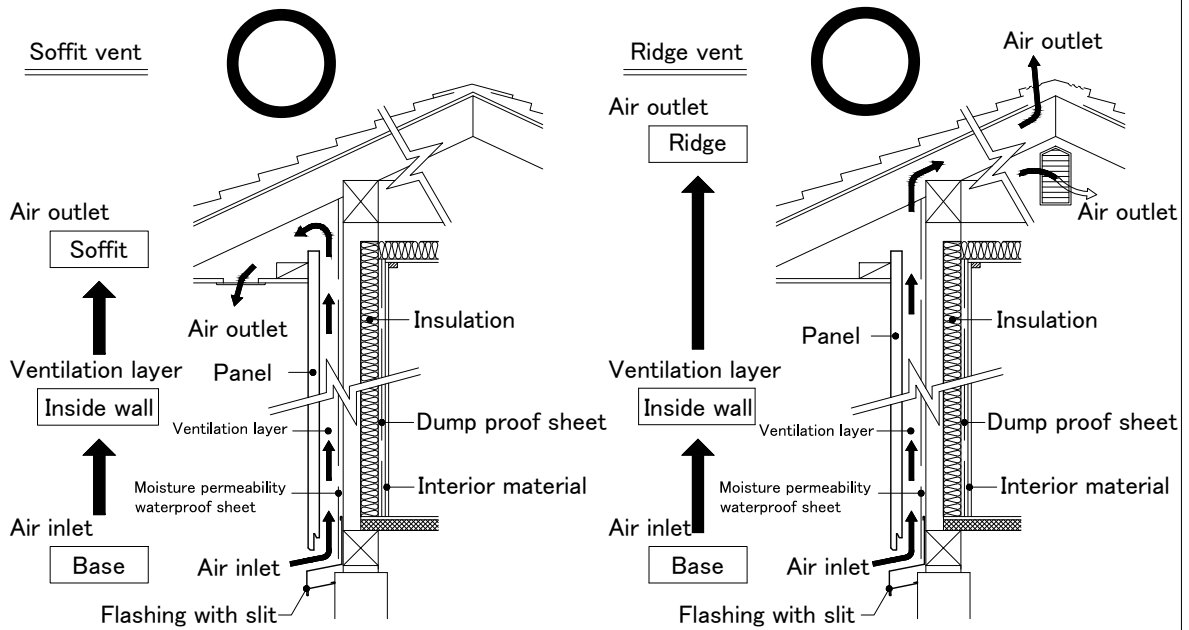

Structure where air in the wall does not flow

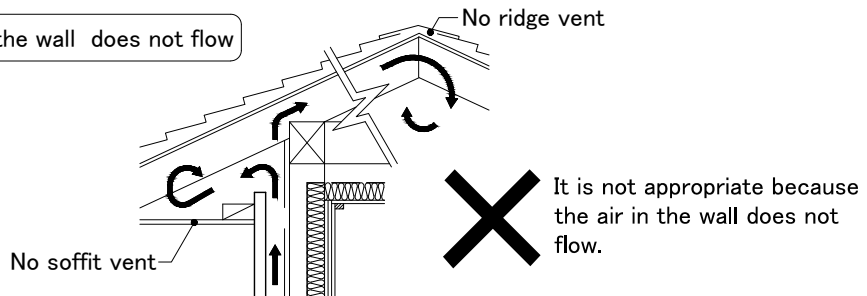

Structure where air in the wall flows effectively

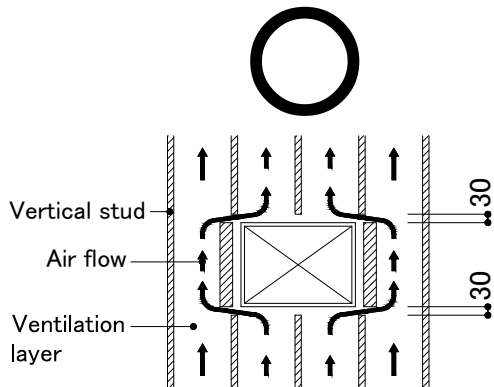

There are spaces around the openings for air flow.

Structure where air in the wall does not flow

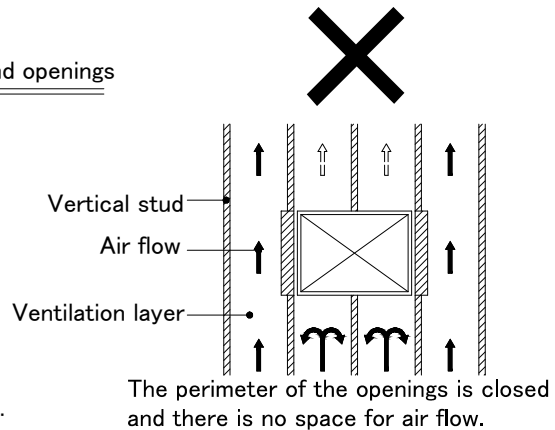

Around openings

# Standard installation method

## 6 Rainscreen system

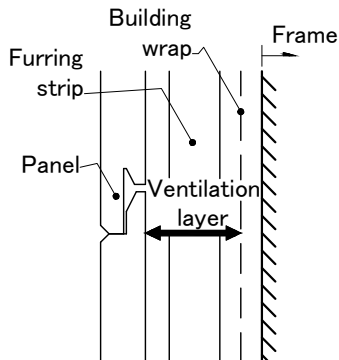

Rainscreen system requires over 12 mm thickness of ventilation layer.

- Air flows when the ventilation layer is at least 7 mm thickness, however, if there is a lot condensation water in the wall due to heavy rain, it may be not be able to be discharged. Therefore the ventilation layer must have over 12 mm thickness.

Furring strip must be over 15 mm thickness.

- When fixing the panels to the furring strip with nails or with 5 mm clips, the furring strip must be over 15 mm thickness to ensure holding force of nails or screws.

## 7 Accuracy of wall stud (steel frame)

(1) Vertical tolerance and evenness of steel stud

- Vertical tolerance of steel stud shall be within 3 mm and  $H/1000$ .
- Unevenness of vertical plane shall be within 3 mm.

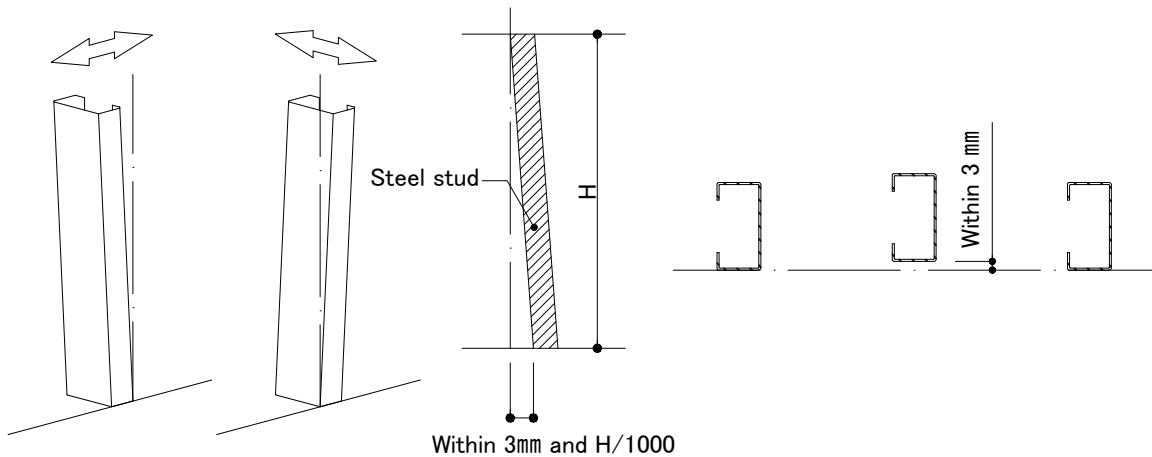

(2) Limit of unevenness

- unevenness because of the gap of vertical stud joint part, welding burr, or sticking out of such as screw heads shall be within 2 mm.

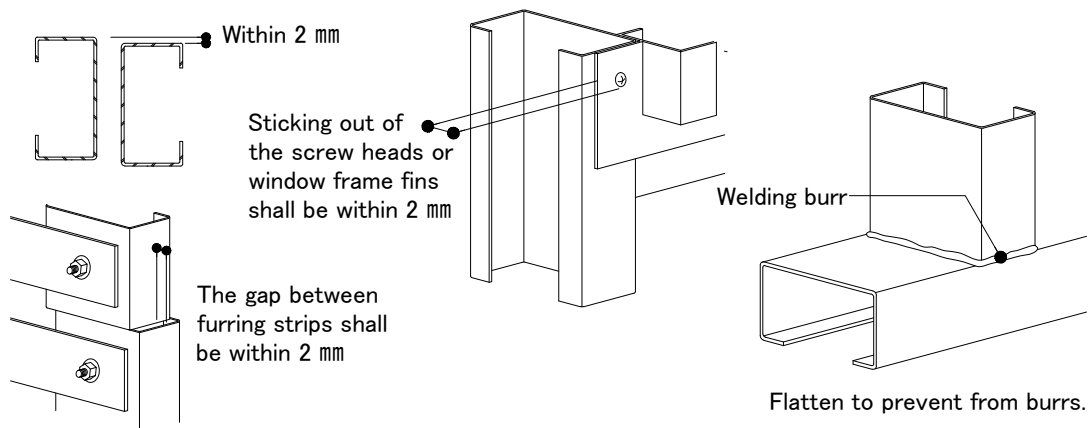

# Standard installation method

## 8 Panel notching

● In principal, the notch depth of the panels shall be within 1/2 of the panel width (455 mm). On the layout, when unavoidably the panel shape is as following (1) or (2) case, be sure to cut the panel and make a sealant joint.

(1) In U-shape, remaining width is less than 1/2 of the panel width

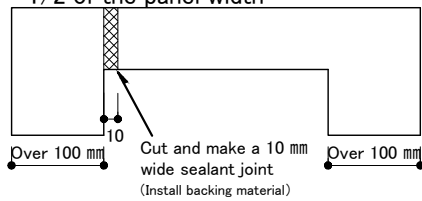

(2) In L-shape, remaining width is less than 100 mm

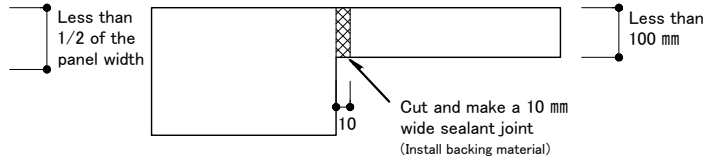

### Prohibited Regarding to notching

Around opening, it is possible to install the notched panel in one body than being cut. The notched panel, however, can be cracked easily after installation. Be sure to cut the notched panel into several pieces and make a sealant joint.

Left photo shows a failure case of crack in corner of a opening part without sealant joint.

### Precautions for installation

#### 1. Cutting

Use diamond tip saw blades and do not cut to the end at one stroke. Be sure to stop cutting at approx. 5 mm before the cutting position. Finish the remaining part with a hand saw.

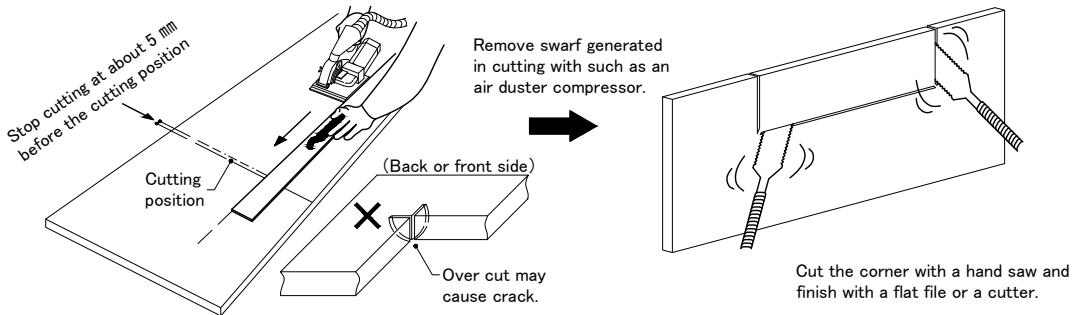

#### 2. Handling

After notching, on scaffold be cautious enough of carrying the panels.

#### 3. Fixing

##### <Fixing procedure>

In advance be sure to drill pilot holes on the notched panel.

Do not drive Nichiha nails completely but leave their heads higher about 3 mm from the surface of the panel.

Drive nails firmly using a nail set to prevent from cracking due to unevenness.

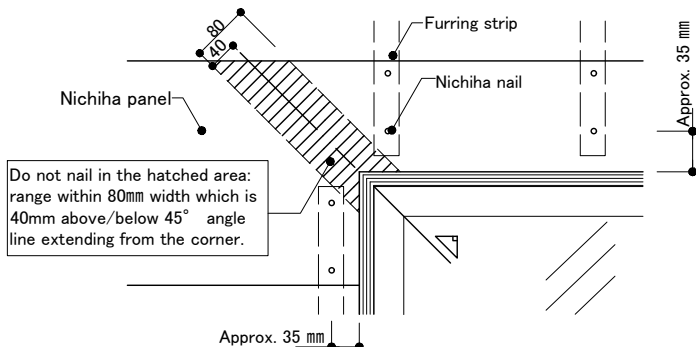

# Standard installation method

## 9 Repair coating

 Keep in a cool place

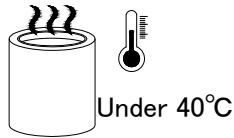

It's dangerous to store paint at high temperatures. Store it in a place under 40 °C.

 Stir well



Without stirring enough, the color may not match.

 Do not spread out overly

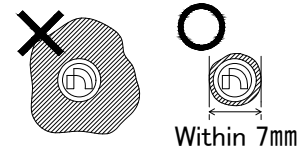

Apply paint to the minimal area, especially apply to nail heads within 7 mm diameter.

### (1) Repair coating procedure

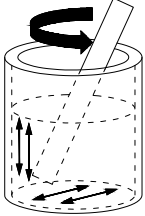
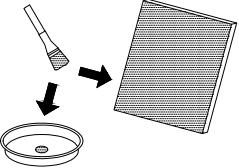
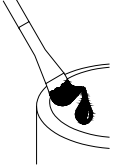
Steps	Work contents	Remarks
1. Before use	<ul style="list-style-type: none"> <li>•Make sure that the surface for paint is sufficiently dry.</li> <li>•Wipe it off if the surface is dirty or dusty.</li> </ul>	<ul style="list-style-type: none"> <li>•Perform the repair coating at the temperature of 5°C or higher.</li> </ul>
2. Paint preparation	<ul style="list-style-type: none"> <li>•Open the lid and stir for over 2 minutes by a stick as if dissolve the mass on the bottom and sides of the container.</li> </ul> 	<ul style="list-style-type: none"> <li>•Use the paint as it is without diluting.</li> <li>•Some products use special solvents. Do not use commercial thinner as the paint will deteriorate and disable its function as expected.</li> </ul>
3. Test paint	<ul style="list-style-type: none"> <li>•Ensure that the color tone matches with the sample on by test painting to the leftover panel.</li> </ul> 	<ul style="list-style-type: none"> <li>•For multi-color set products, select a color according to the surface material color at the application position.</li> </ul>
4. Repair work	<ul style="list-style-type: none"> <li>•Soak the paint into the brush and remove excess paint using the rim of the container.</li> <li>•Apply only to the area to be repaired, not to spread out more than necessary.</li> <li>•Close the lid tightly and store when stopped working. Please complete the work in the day.</li> </ul> 	<ul style="list-style-type: none"> <li>•Apply the paint to as small as possible to the nail heads or scratched part in accordance with the texture of the panel.</li> <li>•Thick coating may cause higher glaze.</li> </ul>

\* For the paint that contains hardener, additives or sand, please follow the below-noted procedure.

1st: Stir the main agent can for over 1 minute.

2nd: Add the entire package to the can and stir for over 2 minutes before use.

After adding the entire package, the curing and color change will progress with time, so avoid high temperature and complete the work in a short time.

Add everything to one bottle/bag for one can.

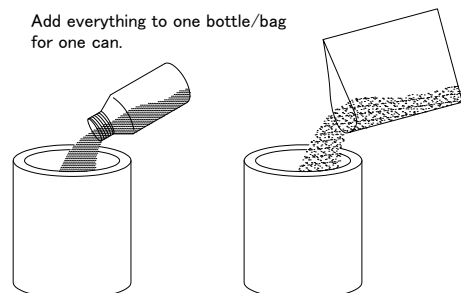

# Standard installation method

## 9 Repair coating

### (2) Notice of the work

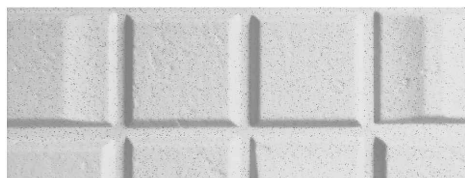
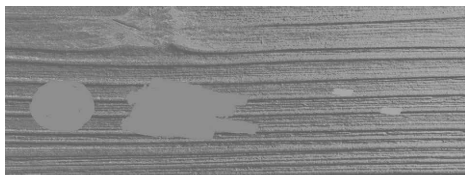
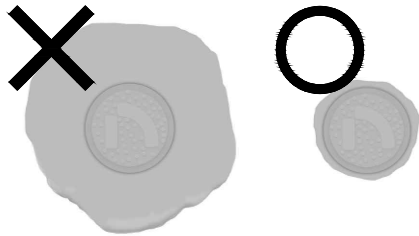

- Do not apply the paint thick or wider than the nail head area. During the construction, the area that needs to be repaired may be dark by the scaffolding or netting and difficult to find.
- If the area that needs to be repaired is large, it may be noticeable after the scaffolding is detached, so apply carefully.
- Apply as small as possible to the scratches and chips corresponding to the shape of the texture.
- In the case of large scratches, replace the board instead of repairing by repair coating.
- If the texture is 30mm or less in height and width, it may not be noticeable if the piece is filled.

### (3) Repair coating of panel edge

Do not apply sealant to cut edge and lower edge of vertical installation panel. Make sure to coat sealer (JF1403) twice, that is to repaint after first paint dries. Also in part where cut edge appear (e.g. in case of using a hanging wall member), apply and dry sealer, and coat touch-up paint.

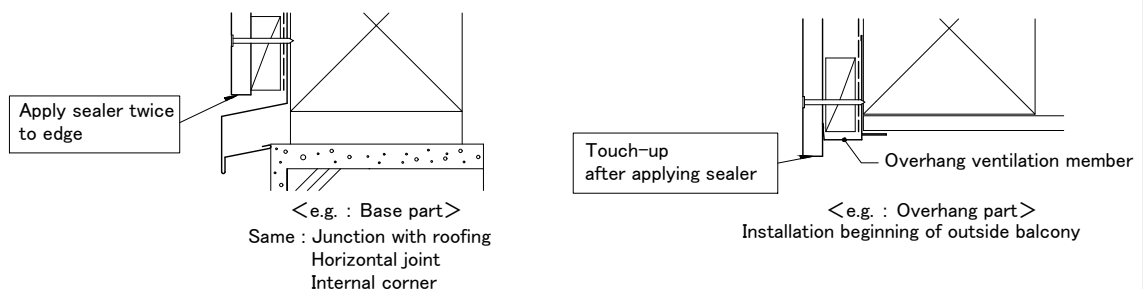

### (4) Repair coating of Nichiha screw head

When the panels are fixed with Nichiha screws, drive them in so that the screw heads are about 1mm lower than the surface of the panels, and apply putty (FC5000) to the screw heads to repair. After drying the putty, apply touch-up paint to only putty area.

Do not use sealant to repair the nail or screw heads. There is a risk of bleaching and becoming noticeable due to deterioration or contamination of sealant.

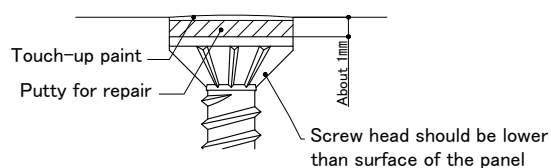

# Standard installation method

## 10 Storage/Handling/Transportation

### (1) Storage

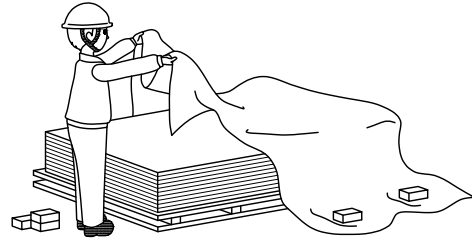
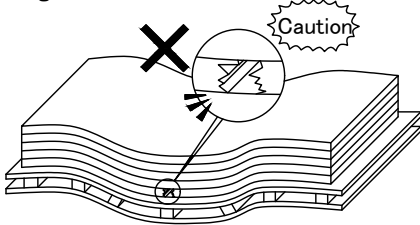

- When storing, put the panels on a pallet or spacers in horizontal place. Intervals between the spacers should be 455mm or less.

- Be sure to cover the panels with sheet to prevent the panels from being wet at the site where the panels can be wet. The sheet packing the panels at delivered is not for waterproof.

- Do not place a pallet which loading the panels on the pallet which loading fewer panels. It may cause the panels to break .

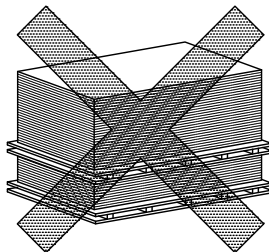

- Do not place the panels directly on the ground, keep them out of water. Install of wet panels may cause the panels to expand and shrink, warp, or crack. Also, painting or filling sealant on wet panels may leads to peeling of coating and breakage of the sealant.

### (2) Handling

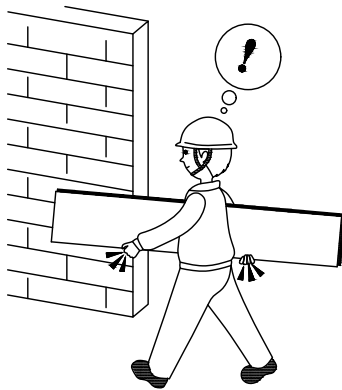

- Carry the panels on edge to prevent cracking.
- Be careful not to damage corners or surface of the panels by hitting them against something or dropping them.
- Do not touch the panels with dirty hands or gloves.
- Pay attention to surrounding and watch your step when carrying the panels.
- Carry by two or more people for one package.



- Be careful not to damage the edges and surface of pre-formed corners or accessories by hitting them against something or dropping them.

### (3) Transportation

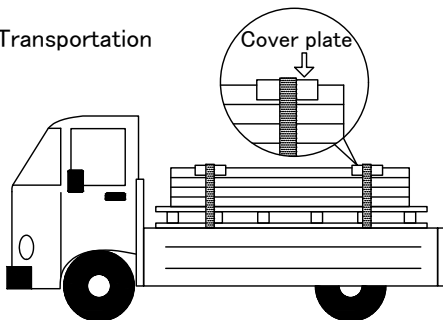

- When transporting the panels by a vehicle, the panels must be piled flat. Be cautious of dirt and rain.
- In order to prevent damage due to sudden braking, apply plates to edges and fix the panels with wire.
- When lifting the panels up, set cover plates on edges of the panels to prevent from damage.
- Be careful not to damage the corners and surface of panels during loading/unloading.

Caution



Nichiha Co. is not responsible for damage caused by improper storage and handling of products.

# Standard installation method

## 12 Procedure and point of sealing work

### (1) Weather check

- Perform sealing work in warm, no wind and sunny day.
- If the previous day was raining, confirm the bonding surface is dry enough before work.

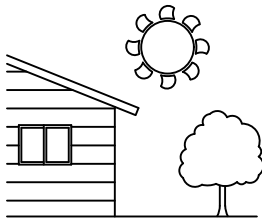

### (2) Clean the surface to adhere

- Remove dust, grease and moisture of the bonding surface. They may cause poor adhesion of sealant.

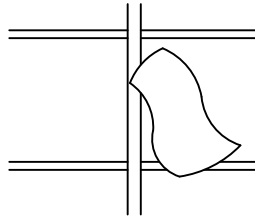

### (3) Check the joint width Install backing material

- Be sure use to genuine joint backer strip which is suitable for thickness of panels and installation method.
- Use genuine joint backer strip in purpose of to ensure appropriate joint width and depth and to prevent from three-sided adhesion of sealant.

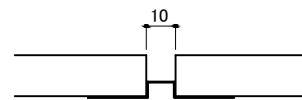

### (4) Curing by masking tape

- Paste masking tape along the caulk line just before sealing work.
- Fit masking tape to unevenness and put on exactly the edge in order to cover painted surface of the panels. If sealant adheres thinly to panel surface, it can be bleached in short period.

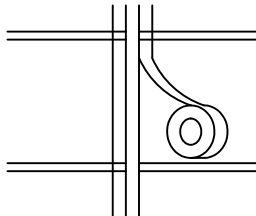

### (5) Application of primer

- Apply primer evenly not to leave unpainted area, especially thickly to cut edge, then dry it over 30 minutes, apply sealant within 6 hours.
- No application of primer, use other products or reuse of opened products may cause poor adhesion.

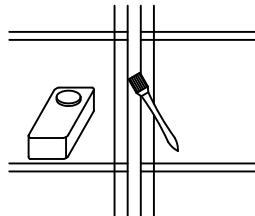

### (6) Fill sealant

- Use a suitable nozzle for the joint width and fill sealant more than enough as they are no bubbles, no unfilled, or no room. Insufficient filling may cause poor adhesion.

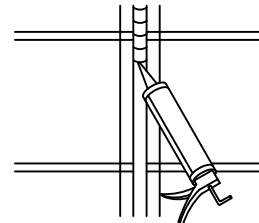

### (7) Press and finish

- Press the surface of the sealant with caulk spatula or similar tool to ensure an even surface. Poor pressing may cause poor adhesion.

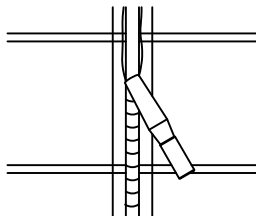

### (8) Remove the masking tape

- Remove the masking tape carefully before the sealant cures by wrapping the tape around a stick.

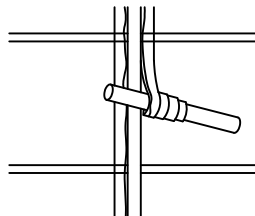

### (9) Cleaning

- Wipe tape glue and excess sealant on the surface of the panel off immediately by a cloth containing sealing cleaner (JF6000), after that wipe by a dry cloth. Insufficient cleaning may cause discoloration or stains.

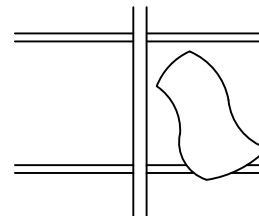

### Caution



- If the sealant surface is painted, the paint can be cracked.
- Avoid using anti-stain spray because it spreads out about 20 cm width on the panel, and causes uneven color or gloss, dirt or discoloration by aging, or decline of hydrophilic.
- If the sealant is scraped overly when finishing, cut edge of the panel can be exposed.

# Standard installation method

## 12 Precaution for sealing work

Be sure to use the primer designated for the sealing. If the primer is applied poorly to the cut edge of the panel, it may cause adhesive failure of the sealant and the panel.

Primer is an **adhesion aid material** for sealant.

### ■ Effect of primer application

- Fill in micropore on the cut edge, and enlarge bonding area
- Prevent from shifting of moisture and alkaline components from the panel to the sealant
- Prevent from shifting of components of the sealant to the panel
- Reinforce the bonding surface      ● Give and enhance adhesion

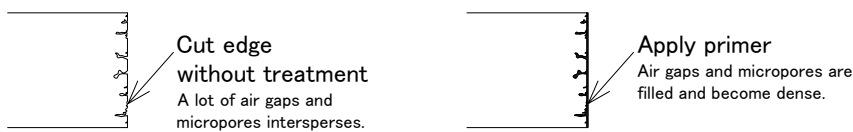

## 13 Sealant

- The panels expand and contract constantly due to change of ambient temperature or humidity. Sealant plays an important role as a buffer and waterproof material.
- Install a genuine joint member of Nichiha and fill in sealant.
- Depending on types of masking tape or how to put on, surface paint of the panel can be peeled off. Accordingly, be cautious of the following points during sealing work.

- \* Precautions
- Do not use the masking tape with strong adhesion.
  - Do not leave the masking tape pasted for more than one day. Also, do not leave in raining day.
  - Do not remove masking tape forcefully.
  - Wipe the sealant and primer which are out of the masking tape off by a cloth containing sealing cleaner (JF6000), after that wipe by a dry cloth.
  - If tape glue remains, make it soft by soaking (hot) water with a cloth and wipe it off.

## 14 Prevention of three-sided adhesion of sealant

- On the sealant joint, various external forces cause movements and stress. It is important to bond the sealant only to the left and right edge, that is two-sided adhesion.
- Genuine joint backer strips of Nichiha are treated fluorine resin coating to prevent from three-sided adhesion.

### <Two-sided adhesion>

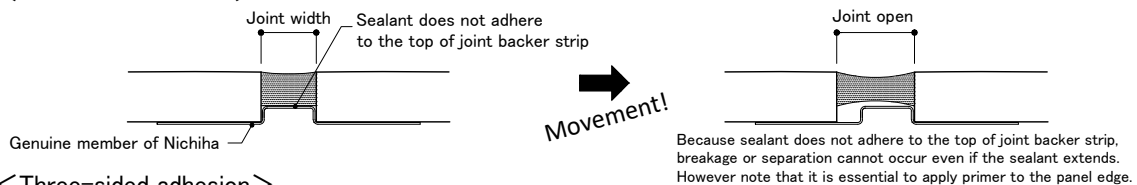

### <Three-sided adhesion>

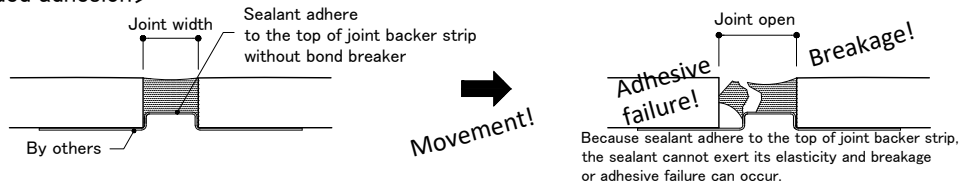

### Caution



Even if two-sided adhesion, no application or insufficient application of primer can cause adhesive failure. In addition, if the previous day was raining and the day of work is sunny, moisture evaporates due to sunlight and temperature, however water between the joint backer strip and the panel edge may remain. Wipe water off by a cloth, and apply primer and fill sealant in surely dry condition of the joint part. Even if primer is applied to wet joints, primer cannot perform as an adhesion aid material then adhesive failure may occur in afterwards.